



**DEPARTMENT OF COMMUNITY
DEVELOPMENT**

PLANNING - BUILDING INSPECTIONS – ZONING
207 WEST SECOND AVENUE, FRANKLIN VIRGINIA 23851
OFFICE: 757-562-8580 OR 757-562-8682

**ZONING CLEARANCE APPLICATION
SWIMMING POOLS AND SPAS**
A site plan is required.

FEE: \$25.00

DATE: _____

APPLICANT NAME: _____

ADDRESS: _____

PHONE (HOME): _____ (BUSINESS): _____

EMAIL ADDRESS: _____

PROPERTY ADDRESS: _____ ZONED: _____

OWNER (If other than applicant) : _____ PHONE: _____

OWNER ADDRESS: _____

DESCRIBE PROPOSED USE: (also attach site plan) _____

IS PROPERTY LOCATED IN THE SPECIAL FLOOD HAZARD AREA? (100 year flood plain) YES: NO:

THE APPLICANT/OWNER IS RESPONSIBLE FOR OBTAINING ALL APPLICABLE STATE AND/OR FEDERAL PERMITS REGULATING THE USE OF THE PROPERTY. IT IS UNDERSTOOD THAT NO CHANGE IN USE SHALL BE MADE WITHOUT THE APPROVAL OF THE ZONING ADMINISTRATOR.

SIGNED: _____ DATE: _____

APPLICANT

OFFICE USE ONLY

APPROVED: CONDITIONAL APPROVAL: DENIED:

REASON FOR DENIAL: _____

CONDITIONS: _____

SIGNED: _____ DATE: _____

ZONING OFFICER

ALL SECTIONS MUST BE COMPLETED

Franklin Building Permit Application

207 West 2nd Avenue, Franklin, VA 23851, Phone (757)562-8580

Must be accompanied with required construction documents from the attached list.

A permit is hereby requested for the construction, alteration, repair or demolition of a structure located at:
Address _____ Tax Map Number _____

Total Contract Amount, including labor and materials \$ _____
Check all that apply: Building ___ Electrical ___ Plumbing ___ Mechanical ___ Other _____

All contractors must submit a copy of their current Virginia Contractor's License at the time of application.
Contractor's/Tradesman License Number: _____ Class _____ Type _____

Name, Address, Phone Number, Email Address of Contractor: _____

Name, Address, Phone Number, Email Address of Property Owner: _____

Structure is: New ___ Existing ___ Addition ___ **Located in the Enterprise Zone** ___ Yes ___
No Residential ___ Commercial ___ Industrial ___ HUD Home ___ Modular ___ Other _____

Lien Agent Name, Address, Phone Number _____

Is property located in the Special Flood Hazard Area? (100 yr. floodplain) ___ Yes ___ No

General Description of Work: _____

This construction to comply with 2015 ___ or 2018 ___ (check one) VBC ___ VRC ___ HUD ___

The structure / addition listed herein may not be occupied until such time as the Final Inspection has been passed and/or the Certificate of Occupancy has been issued by this office.

Check one: Owner: ___ Owner Agent: ___ Contractor: ___

Signature _____ Date _____

FOR OFFICE USE ONLY: Application received by: _____ Date: _____

City of Franklin Community Development Department

Application Package List - for New Construction of or Additions to One and Two Family Dwellings and Accessory Structures (Contact our office for list on Commercial and E&S / SWM applications)

- ___ Building Permit Application
- ___ Two Sets of Site Plan
- ___ Stormwater Management Waiver Application
- ___ Copy Zoning Permit by City(if applicable)
- ___ E&S /SWM Permit or In-lieu of Permit Agreement
- ___ Shrink Swell Soil Test for Site (new construction, or addition exceeding 40% of existing footprint) ___ Well & Septic Permit or Tap Fee Receipt
- ___ 1 & 2 Family Residential Plan Submittal Guidelines
- ___ Two Sets of Building Plans
- ___ Two copies of the Dept of Energy, RESCheck
- ___ Two copies of the Brace Wall Calculations
- ___ **Manual J from HVAC Contractor (see below)
- ___ **Manual D from HVAC Contractor (see below)
- ___ Virginia Contractors License or Owners Affidavit
- ___ Contractors City / County Business License

When submitted, the *Application Package* and its accompanying documents will receive a concise review to assure the required information is included before it is date stamped as received. A complete review of the *Application Package* and its supportive documentation will be made on a first come, first served basis. *Application Packages* that are returned for additional information or corrections will be reassigned with a new submission date and placed back into the rotation from that date. A Construction / Plan Review meeting will be scheduled with the Plans Examiner and the Builder on an as needed basis.

Energy and Wind Bracing - With the introduction of new requirements in energy (Chapter 11 VRC) and wind bracing (Section 602.10 VRC), a builder must collect information from his Registered Design Professional or plans designer and exchange information with his construction material supplier and HVAC contractor. The builder must submit two complete copies of a RESCheck from the Department of Energy (see DOE web page) to assure building envelope is code compliant and to assist the HVAC contractor in calculating a Manual S from a Manual J and Manual D. The builder should complete or caused to be completed the digital *Brace Wall Calculation Interactive Form* found on the City or County web pages. **Site Plan** – Two copies of a building site plan / survey must be in the *Application Package*. The survey must have a North indicator. Show the location of all existing structures and the proposed structure in a likeness of the structure's footprint so the front of the building is clearly indicated. Additionally, the distance in feet to any wooded area 25' deep and 30' in height or any structures 30' tall within 600' of the proposed dwelling on the site plan, even if the trees/structures are on another property. The site plan must also include the distance from all four sides of the dwelling to the respective property lines. The name, address, and occupation of the Site Plan/Survey preparer must be included on the document.

Construction Drawings - Two complete, legible, and identical sets of building plans drawn to no less than ¼" per foot scale must be submitted. All supporting documentation, shop

drawings, code furnished drawings, truss or engineered layout, site plan, Manual D and Manual J, RESCheck, layout, etc., must be included. The sequencing of the plan's assembly must follow the same order as the black headings on the *1 & 2 Family Residential Plan Submittal Guidelines (RPSG)* found on city and county web pages. The plans must be secured along the left margin strongly enough to withstand the rigors of the field construction environment.

Plan Review Guideline checklist - All of the items on RPSG must be answered on the Guidelines. Check the "CK" column for relevant items found on your plans. Check the "N/A" column for items not necessary on the plans, such as basement info for a home with no basement planned. The "REJ", "REC" and "REMARKS" columns are for the plans examiner's use.

Permits - When the *Application Package* is reviewed and approved, you will be contacted to pick up the permit. Should the *Application Package* be returned for additional information or corrections, the *RPSG* with the plans examiner's remarks will be returned to you. The original *RPSG* must be returned with the re-submittal. Failure to return the original *RPSG* will result in another complete plan review and a additional plan review fee.

****Manuals D & J** - The Manual D and Manual J do not have to be submitted with the initial *Application Package*; they may be submitted with the HVAC Application. However, an HVAC plan review will be conducted in the normal plan review rotation should the Manuals D & J be submitted separate from the construction plans. Regardless of when the Manuals D & J are submitted, two copies of the RESCheck must accompany the initial (building) *Application Package*.

Fees –All applicable fees, including but not limited to zoning clearance, tap fees, permit fees, E&S fees (if applicable), stormwater fees (if applicable), and administrative fees are payable prior to issuance of any permits.

I have read and understand the above information and requirements for submittal.

Applicants Initials: _____

Building Code Guidelines For Home Pools

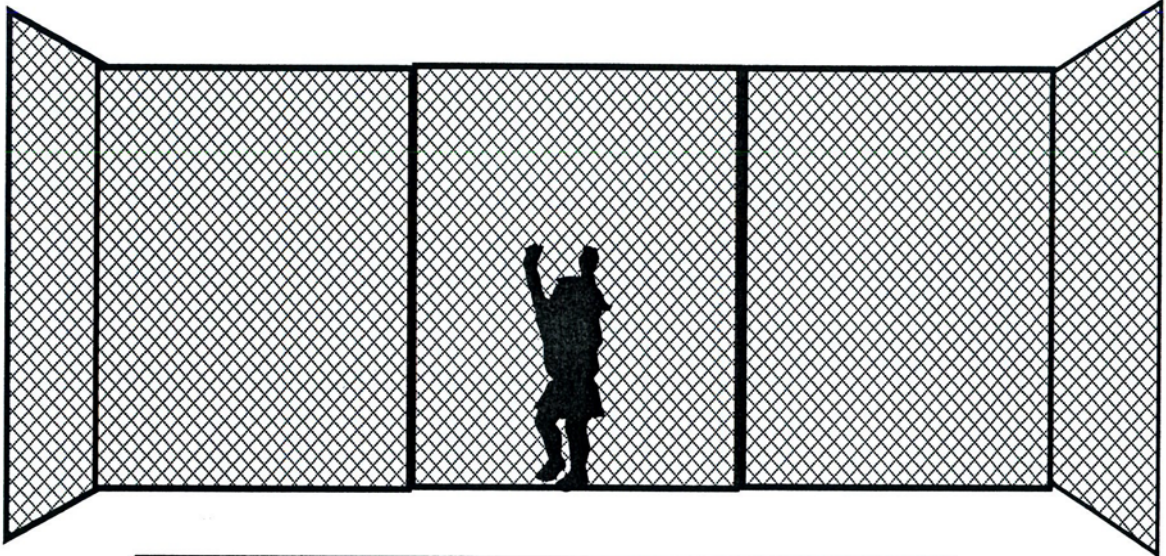

KEEP YOUR POOL
SAFE



Growth • Community • Spirit

Department of Community Development
Planning-Building Inspections-Zoning

CODE REQUIREMENTS FOR SWIMMING POOLS

Localities in Virginia enforce the regulations established by the Virginia Uniform Statewide Building Code (VUSBC) regarding the installation, use and maintenance of all swimming pools, hot tubs and spas for both private and public residential and commercial pools.

No persons shall begin construction of a swimming pool nor substantially alter or reconstruct any swimming pool without having first submitted construction plans and specification to the local building department for review and approval. No work shall be commenced until having first obtained the required permits for the pool, electrical work, mechanical work and fence or barrier protection as required by the regulations.

It is unlawful for any person to construct, maintain, use, possess or control any swimming pool not properly protected by a permanent fence or barrier in accordance with the regulations regardless of the date of construction. Any person who shall violate any provisions of the regulations may be subject to legal action as allowed by the VUSBC.

PERMITS

A building permit is required for installing all structures intended for swimming, recreational bathing or wading that contains water over 24 inches deep. This includes in-ground, aboveground, and on-ground pools: hot tubs spas and fixed in place wading pools.

Exception: Swimming pools that have a surface area not greater than 150 sq. ft. (approx. 13.8 ft. in diameter), do not exceed 5,000 gallons and are less than 24 inches.

An electrical permit is required for any electrical circuits or electrical work added for the pool and a gas or mechanical permit is required for pool heaters or other mechanical equipment for the pool.

The property owner is responsible for ensuring the pool is properly protected by a fence or barrier meeting code requirements during construction and after completion and approval.

The permit holder is responsible for assuring all inspections have been completed and approved including fence protection prior to using the pool. The following information is required to obtain a permit:

1. A site plan shall be submitted that accurately show the dimensions and construction of the pool to include walks, fence enclosures and proposed distances to lot lines.
2. The wall of a pool shall not encroach on any set back required by the governing zoning ordinance. A wall of a swimming pool shall not be located less than six (6) feet from any side or rear property line or ten (10) feet from any street property line.
3. All appurtenant structures, installations and equipment, such as showers, dressing rooms, equipment houses or other buildings and structures, including plumbing,

electrical and HVAC systems shall comply with all applicable requirements of the code and authority having jurisdiction.

4. The pool shall be equipped to be completely emptied of water, and such discharge water shall be disposed of in an approved manner that will not create a nuisance to any adjoining property.

Outdoor private swimming pools, including an in-ground, above-ground or on-ground pools, hot tub or spa shall be provided with a barrier. Access gates for private pools shall be equipped to accommodate a locking device.

Swimming Pool Barrier Guidelines

A successful pool barrier prevents a child from getting **OVER**, **UNDER**, or **THROUGH** and keeps the child from gaining access to the pool except when supervising adults are present. A young child can get over a pool barrier if the barrier is too low or if the barrier has handholds or footholds for the child to use when climbing.

The top of a pool barrier must be at least **48 inches** above grade, measured on the side of the barrier which faces away from the swimming pool.

For a Solid Barrier: no indentations or protrusions shall be present, other than normal construction tolerances and masonry joints.

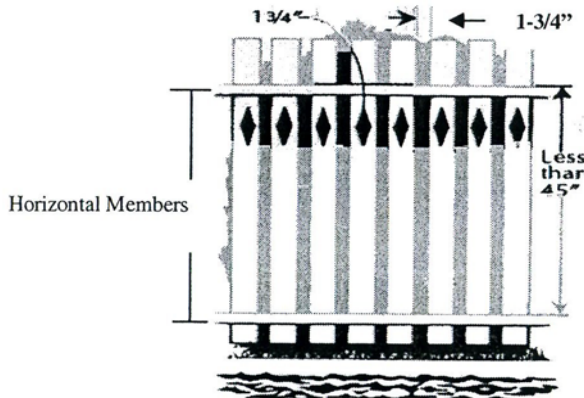
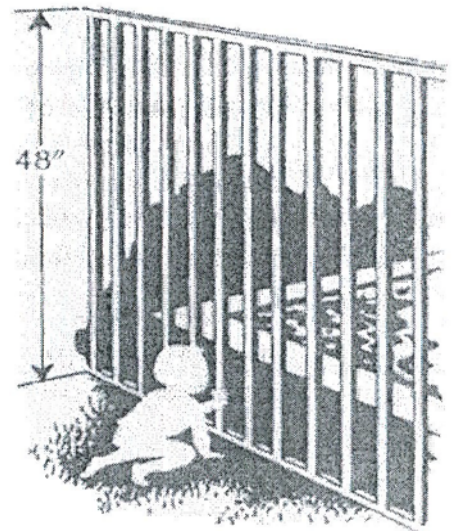
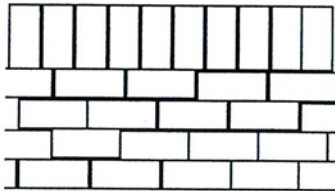

Barriers (Fences) Made Up of Closely Spaced Horizontal Members:

If the distance between the tops of the horizontal members is **less than** 45 inches, the horizontal members shall be on the swimming pool side of the fence. The spacing of the vertical members shall not exceed 1-3/4 inches. This size is based on the foot width of a young child and is intended to reduce the potential for a child to gain a foothold. If there are any decorative cut-outs in the fence, the space within the cutouts shall not exceed 1-3/4".

Barriers (Fences) Made Up of Widely Spaced Horizontal Members

If the distance between the tops of horizontal members is **more than** 45 inches, the horizontal members may be on the side of the fence facing away from the pool. The spacing between vertical members should not exceed 4 inches. This size is based on the head breadth and chest depth of a young child and is intended to prevent a child from passing through an opening. Again, if there are any decorative cutouts in the fence, the space within the cutouts shall not exceed 1-3/4 inches.

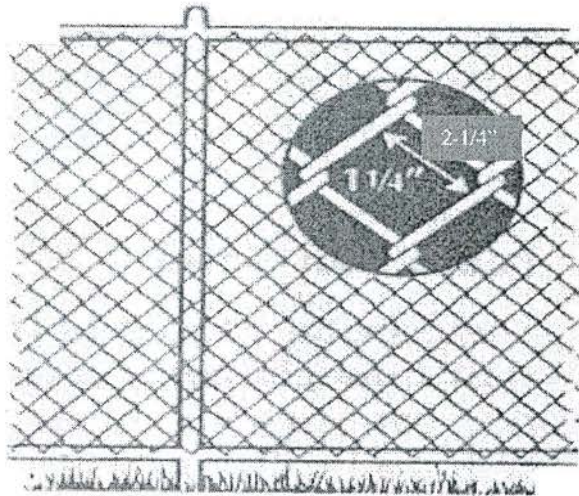
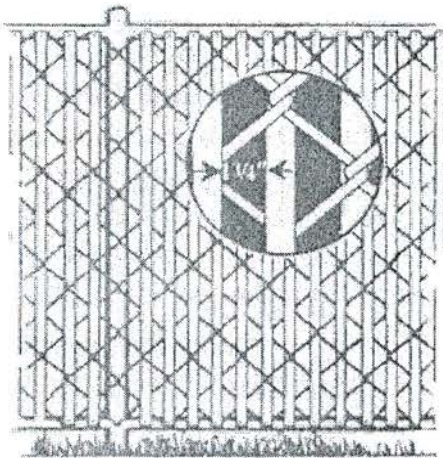
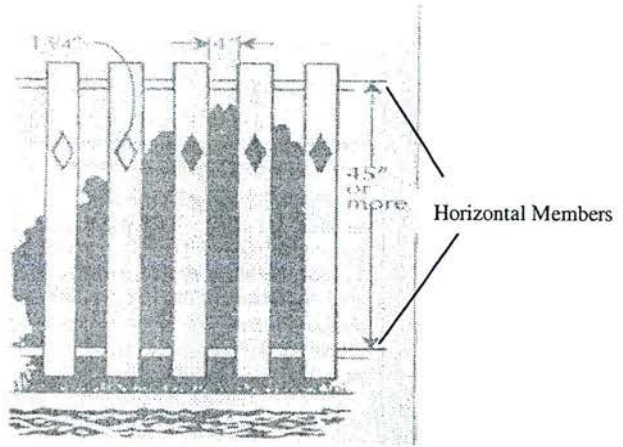

Barriers Made of Chain Link Fence

The mesh size shall not exceed 2-1/4 inches square unless slats, fastened at the top or bottom of the fence, are used to reduce mesh openings to no more than 1-3/4 inches.

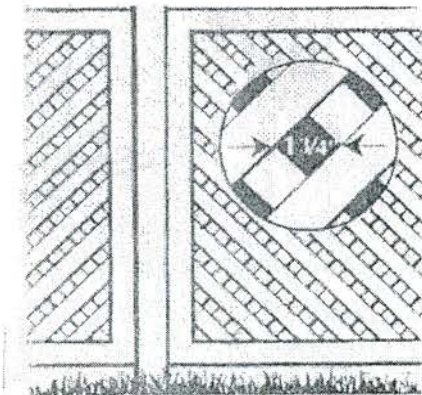

Barriers Fences Made Up of Diagonal Members (Latticework)

The maximum opening in the lattice should not exceed 1-3/4 inches.

In-ground Pools

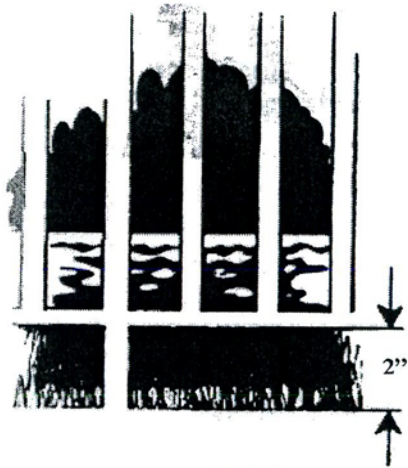

For any pool barrier, the maximum clearance at the bottom of the barrier shall not exceed **2 inches** above grade, when the measurement is done on the side of the barrier facing away from the pool.

Above-ground Pools

Aboveground pools shall have barriers. The pool structure itself may serve as a barrier fence or a barrier is mounted on top of the pool structure.

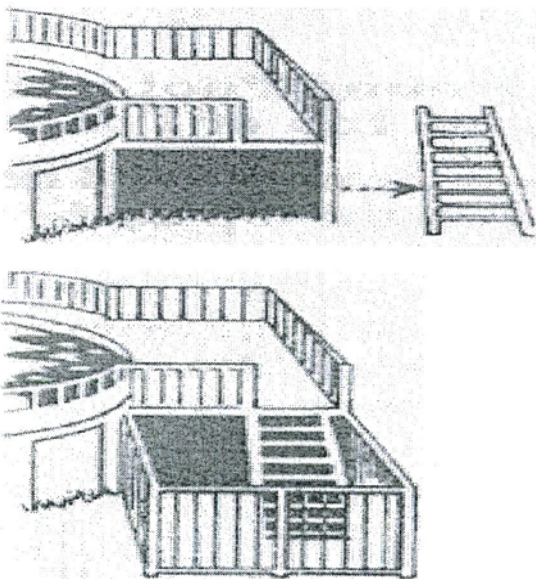
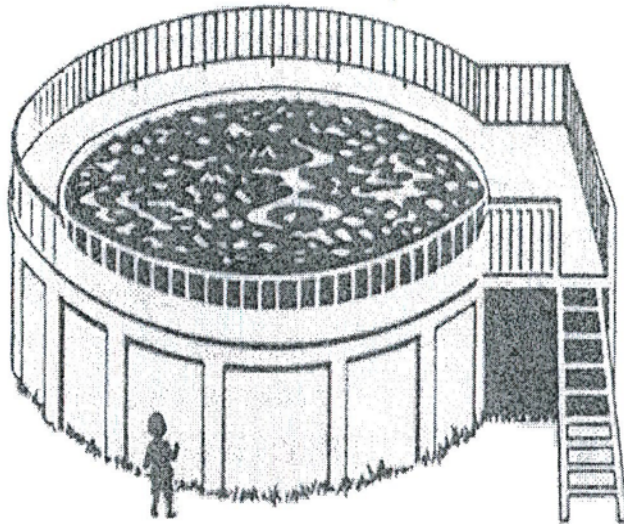

The steps or ladder can be designed to be secured, locked or removed to prevent access, or the steps or ladder can be surrounded by a barrier such as those described above.

ABOVE-GROUND POOL WITH BARRIER ON TOP OF POOL

If an **above-ground** pool has a barrier on the top of the pool, the maximum vertical clearance between the top of the pool and the bottom of the barrier shall not exceed **4 inches**.

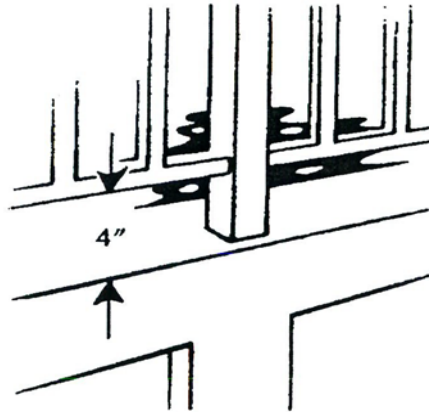

GATES

There are two kinds of gates which might be found on residential property. Both can play a part in the design of a swimming pool barrier.

PEDESTRIAN GATES

These are the gates people must walk through. Swimming pool barriers should be equipped with a gate or gates which restrict access to the pool. A locking device must be included in the gate design. **Pedestrian gates must open outward and away from the pool and shall be self-closing and self-latching.**

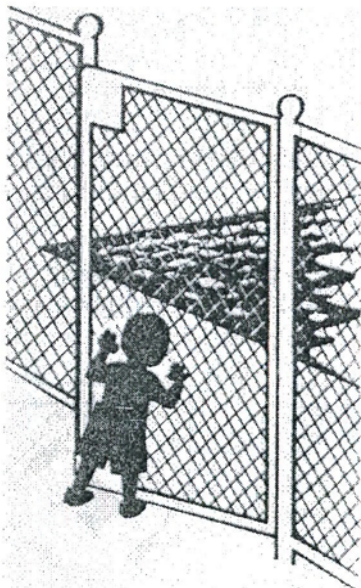

If a gate is properly designed, even if the gate is not completely latched, a young child pushing on the gate in order to enter the pool area will at least close the gate and may actually engage the latch.

Where the release mechanism of the self-latching device is **less than** 54 inches from the bottom of the gate, the release mechanism for the gate shall be located on the pool side of the gate and be at least 3 inches below the top of the gate on the side facing the pool. Placing the release mechanism at this

height prevents a young child from reaching over the top of a gate and releasing the latch. Gate latches installed in this manner shall have no openings greater than ½ inch with 18 inches of the latch release mechanism. This prevents a young child from reaching through the gate and releasing the latch.

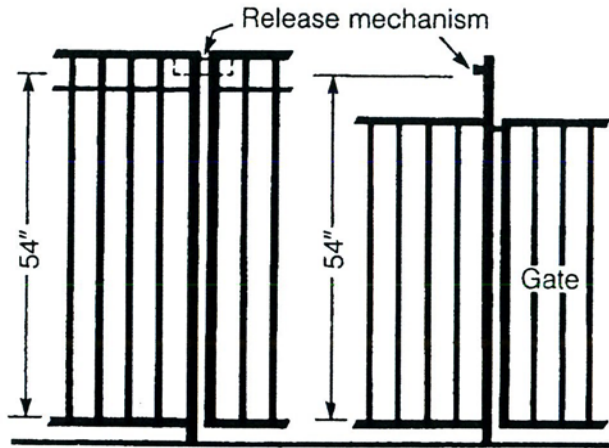

The release mechanism shall be located at 54" or higher from the bottom of the gate.

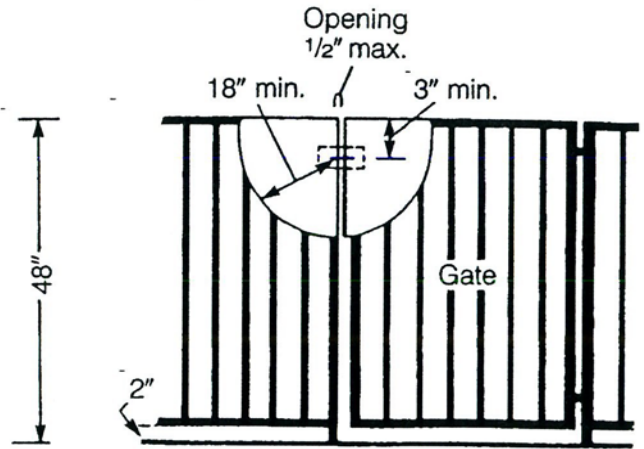

The release mechanism shall be located less than 54" from the bottom of the gate.

ALL OTHER GATES (Vehicle Entrances, ETC.)

Other gates must be equipped with self-latching devices. The self-latching devices must be installed as described for pedestrian gates.

WHEN THE HOUSE WALL FORMS PART OF THE POOL BARRIER

In many homes, doors open directly onto the pool area or onto a patio which leads to the pool.

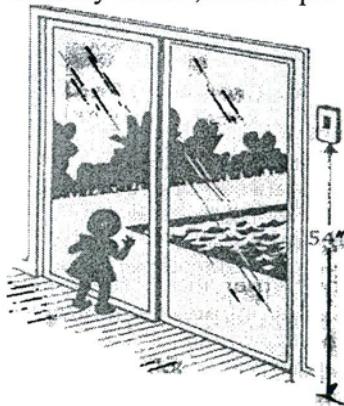

In such cases, the wall of the house is an important part of the pool barrier, and passage through any doors in the house wall must be controlled by one of the following security measures.

1) **All doors which give direct access to a swimming pool must be equipped with an audible alarm which sounds when the door and/or screen are opened.** The alarm must sound for 30 seconds or more immediately after the door is opened. The alarm must be capable of being heard throughout the house during normal household activity. (The alarm sound should be distinct from other sounds in the house, such as the telephone, doorbell and smoke alarm.) The alarm must have an automatic reset feature.

Because adults will want to pass through house doors in the pool barrier without setting off the alarm, the alarm must have a switch that allows adults to temporarily deactivate the alarm for up to a maximum of 15 seconds. The deactivation switch could be a touchpad (keypad) or a manual switch, and must be located at least 54 inches above the threshold of the door covered by the alarm.

2) Pools equipped with a powered safety cover which complies with ASTM F1346 or

3) Other means of protection approved by the building official.



**DEPARTMENT OF COMMUNITY
DEVELOPMENT**

PLANNING - BUILDING INSPECTIONS – ZONING
207 WEST SECOND AVENUE, FRANKLIN VIRGINIA 23851
OFFICE: 757-562-8580 OR 757-562-8682

**SAFETY DEVICES FOR SWIMMING POOLS
AFFIDAVIT**

Definition: Any structure for swimming, recreational bathing, or wading that contains water over 24 inches deep, or a surface area greater than 150 square feet or exceed 5000 gallons. This includes in-ground, above-ground, and on-ground pool, hot tubs, spas and fixed in place wading pools.

I _____ (occupant of property), of (home address) _____, affirm that I am the occupant of a certain tract or parcel of land, Tax Map # _____ located at _____ . I further attest that I or my licensed swimming pool contractor have applied for a building permit to erect a residential swimming pool or spa, as defined above, on the above named property. I affirm that I am aware of the provisions, codes and directions of the current Virginia Uniform Statewide Building Code and it's adopted International Swimming Pool and Spa Code concerning the safe erection of a swimming pool or spa including the requirement to erect and maintain an adequate barrier and/or enclosure surrounding the swimming pool or spa and adequate safety devices in accordance with the International Swimming Pool and Spa Code. I also affirm that I will insure that the required swimming pool, swimming pool barrier and/or enclosure and safety devices will be installed and pass final inspection by this office prior to the operation or use of the swimming pool or spa.

By affixing my signature to this document I swear and affirm the facts attested to in this one page document are accurate, complete and true to the best of my knowledge.

_____ (Affiant signature)

The Affiant, _____ (print) has come before me, a Notary Public in the City of Franklin, VA., and sworn the facts and statements herein are accurate, complete and true to the best of his/her knowledge on this the _____ day of _____, 20__

_____ (Notary). (Print name) _____

My commission expires on _____